

Operates on 120VAC

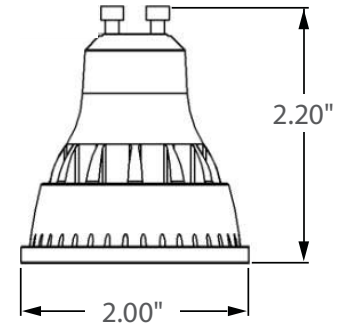

Incredible **25,000** hrs

GENERAL DESCRIPTION

Neptun's high performance LED MR16 - GU-10 bulbs are designed for the replacement of existing halogen bulbs up to 40W. The LED-MR16 series bulbs are offered in a variety of color temperatures for flexibility in all types of applications. Its operating voltage allows for use in 120V applications.

APPLICATION

- Suitable for use in indoor environments
- Not for use in fully enclosed fixtures
- Not for use where directly exposed to water

STRUCTURE, MATERIALS, & FEATURES

- Finned aluminum casting for excellent thermal management.
- Flat polycarbonate shatterproof lens. (Glare Free)
- Wide variety of Correlated Color Temperatures.
- High Luminous Efficacy: > 65 Lm/W
- Environmental Friendly - mercury and lead free.
- Up to 15 years Maintenance free operation.
- Integrated high efficiency driver.
- High Output COB LED's.
- RoHS Compliant.
- No UV or IR radiation.
- 5 Year Warranty.

ORDERING INFORMATION

Sample Number: LED-MR1605-120V-830-GU-10
Custom options and accessories available. Please consult factory

Series	Wattage	Voltage	Color Temp	Base
LED-MR16 = MR16	05 = 5 W	120V = 120 VAC	830 = 3000°K 841 = 4100°K 850 = 5000°K 865 = 6500°K	GU-10 = GU-10



lightinnovations@work™

PRODUCT INFORMATION

Model No.	Watts	Input Line Current (Amp) @ 120VAC	Power Factor	THD	CCT (°K)	CRI	Lumens	Lm/W	Base	Beam Angle
LED-MR1605-120V-830	5	0.043	>0.90	<15%	3,000°	>80	325	65	GU-10	35°
LED-MR1605-120V-841	5	0.043	>0.90	<15%	4,100°	>80	330	66	GU-10	35°
LED-MR1605-120V-850	5	0.043	>0.90	<15%	5,000°	>80	340	68	GU-10	35°
LED-MR1605-120V-865	5	0.043	>0.90	<15%	6,500°	>80	345	69	GU-10	35°

SPECIFICATIONS

- LED Driver Constant Current
- Power Supply 350mA
- Start Method InstantON
- Hot Re-start InstantON
- Operating Voltage 85-265 VAC
- LED / Driver System Life 25,000 Hrs.
- Color Temperature Various
- Color Rendering Index (CRI) > 80
- Minimum Starting Temperature -25°C
- Maximum Starting Temperature +40°C
- Lumens per Watt > 65
- Power Factor > 0.90
- Total Harmonic Distortion < 15%
- FCC Compliance Part 15, Subp. C
- Warranty 5 Year

ENERGY SAVINGS

75% Energy Savings

Operation Costs Comparison over Life of LED Bulb

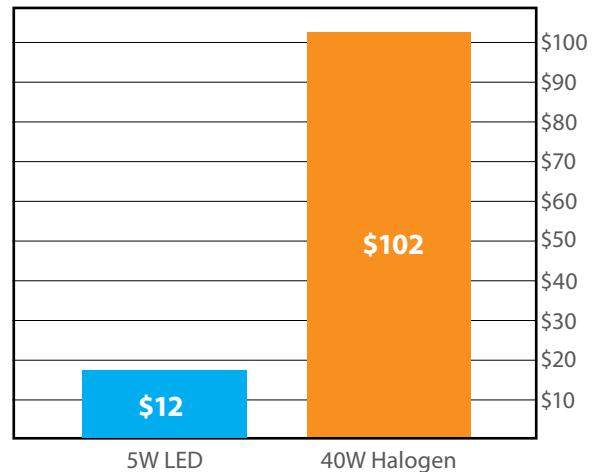

*Based on \$0.10 kw/H
*12Hrs. per Day Usage

Neptun Light, Inc.
13950 Business Center Drive
Lake Forest, IL 60045
Fax: 847.735.8004

Neptun Light, Inc. reserves the right to change materials or modify the design of its product without notification as part of the company's continuing product improvement program.
©2002-2016 Neptun Light, Inc. All rights reserved.

Spec. Rev. 7-2016